

Repartidores EMC / Repartidores EMC Répartiteurs EMC / Splitters EMC

Refs. 542902, 543902, 544902

542902

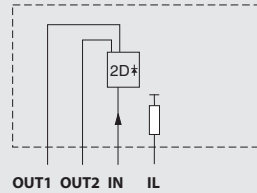

543902

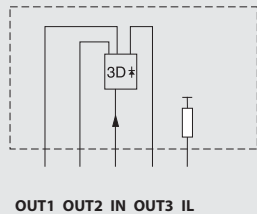
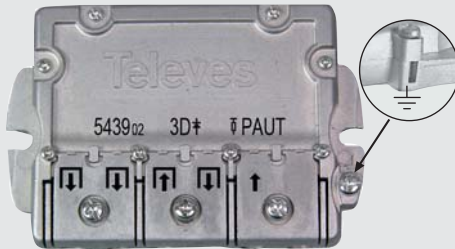

544902

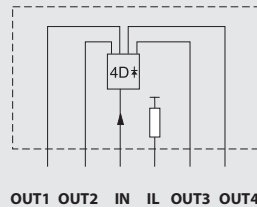

Características técnicas	Características técnicas	Spécifications techniques	Technical specifications			542902	543902	544902
Margen freq.	Margem freq.	Marge fréq.	Freq. range		MHz	5 - 2400 MHz		
Atenuación IN - OUT	Atenuação IN - OUT	Atténuation IN - OUT	Attenuation IN - OUT	5 - 47 MHz	dB (typ)	4,4	8,5	9,3
				47 - 862 MHz		4,5	9	9
				950 - 2400 MHz		4,3	8	7,5
Atenuación IN - OUT3	Atenuação IN - OUT3	Atténuation IN - OUT3	Attenuation IN - OUT3	5 - 47 MHz	dB (typ)	-	5,5	-
				47 - 862 MHz		-	5	-
				950 - 2400 MHz		-	4	-
Rechazo entre salidas	Rejeição entre saídas	Réjéct entre sorties	Rejection between outputs	5 - 862 MHz	dB (typ)	> 15	> 15	> 17
				950 - 2400 MHz		> 15	> 15	> 15
Tensión máx.	Tensão máx.	Voltage max.	Max. voltage		V	40		
Corriente máx.	Corrente máx.	Courant max.	Max. current	OUT - IN	mA	300 *		
Caida D.C.	Queda de DC.	Chute tension	Drop out volt.	OUT - IN		0,35 V (typ) @150 mA		

ES

(*) Sobrepasar el valor indicado puede provocar fallos irreversibles.

Nota: El paso de corriente sólo es posible de las salidas hacia la entrada.

PO

(*) Ultrapassar o valor indicado pode provocar falhas irreversíveis.

Nota: A passagem de corrente só é possível das saídas para a entrada.

FR

(*) Le non-respect de la valeur indiquée peut entraîner des dommages irréversibles.

Note: Passage de courant des sorties vers l'entrée exclusivement.

UK

(*) Exceeding the indicated value can cause irreversible errors

Note: The DC pass can only go from the outputs to the input.

Accesorio / Acessório Accessoire / Accessory

Ref. 4087



75 ohm



Anclaje de brida para facilitar el conexionado
 Encaixe da braçadeira para facilitar a ligação
 Fixation de la bride pour simplifier la connexion
 Cable clamp joint for easy connection.

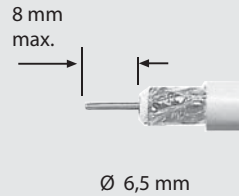
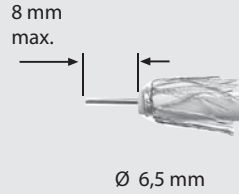

Mismo pelado para cables de una misma brida.
 Mesmo descarnado para cabos da mesma braçadeira
 Même decoupe du câble par bride
 Same stripping for cables with the same clamp.

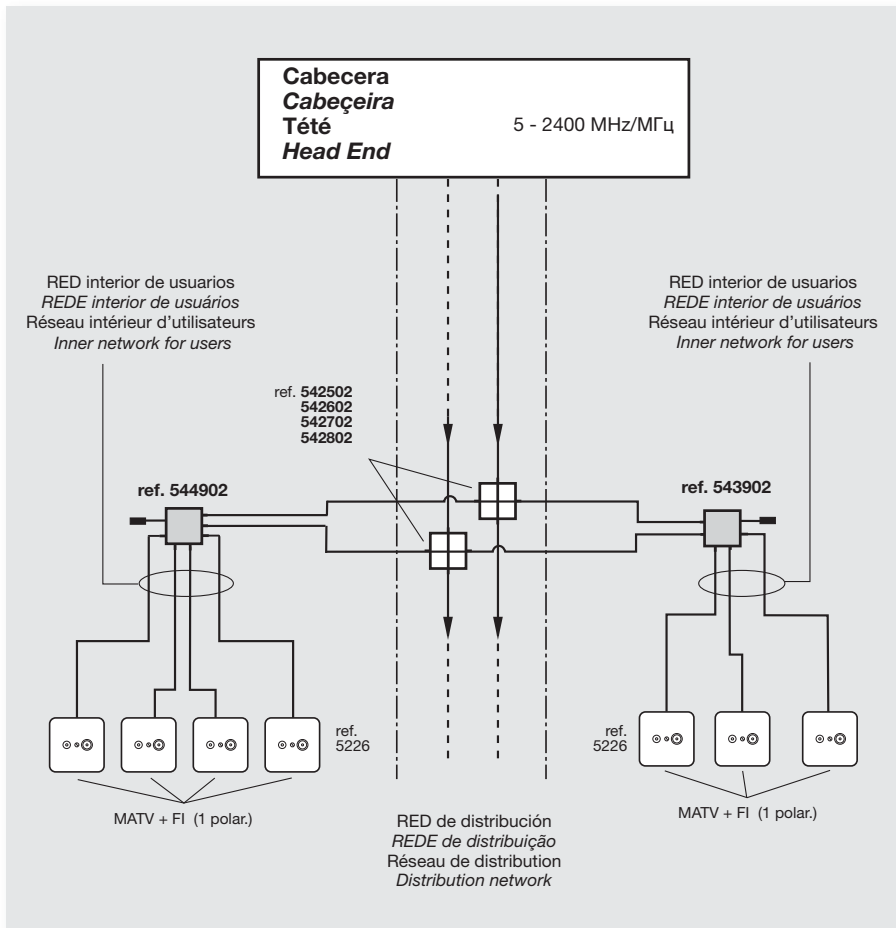

Televes S.A. declara bajo su exclusiva responsabilidad la conformidad de éste producto con las Directivas 2004/108/CEE y 2006/95/CEE.

Puede obtener la Declaración de Conformidad e información complementaria en la página Web:

Televes S.A. hereby states, under its own responsibility, that this product is in compliance with the orders of the Directives 2004/108/CEE and 2006/95/CEE.

You can obtain the Declaration of Conformity and complementary information in the Web page:

<http://www.televes.com>

